

## STRUTTURA CON BASE

### 1 - Assemblare la base:

Inserire il gancio inferiore della base nella prima asola (dal basso) del montante.

Ruotare la base facendo entrare il gancio superiore nella seconda asola del montante.

Bloccare la base inserendo la spina elastica nel foro del montante e del gancio della base.

Inserire dal basso l'innesto per il piedino.

Avvitare i piedini regolabili nel montante e nella base con chiave n°14.

N.B. Il foro del montante deve coincidere con il foro della base per l'inserimento della spina elastica.

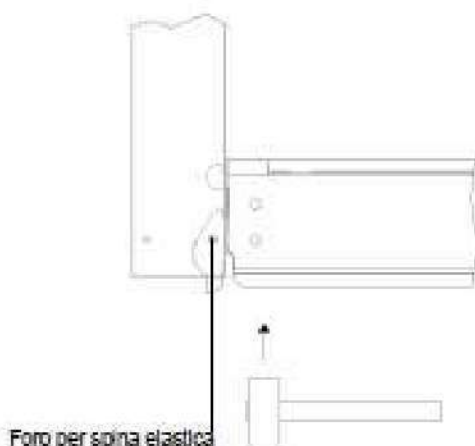
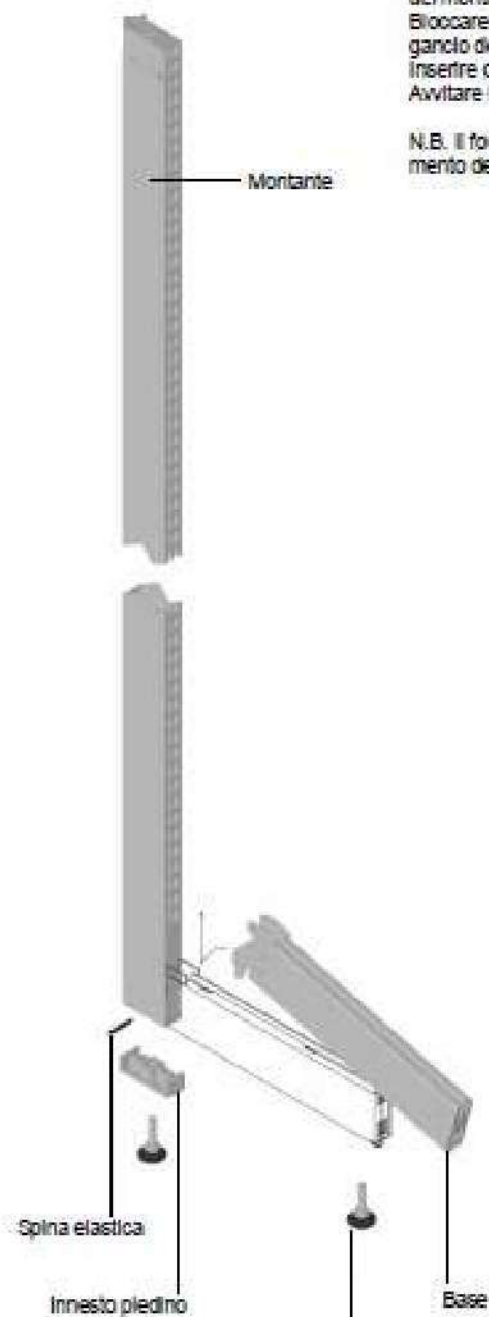

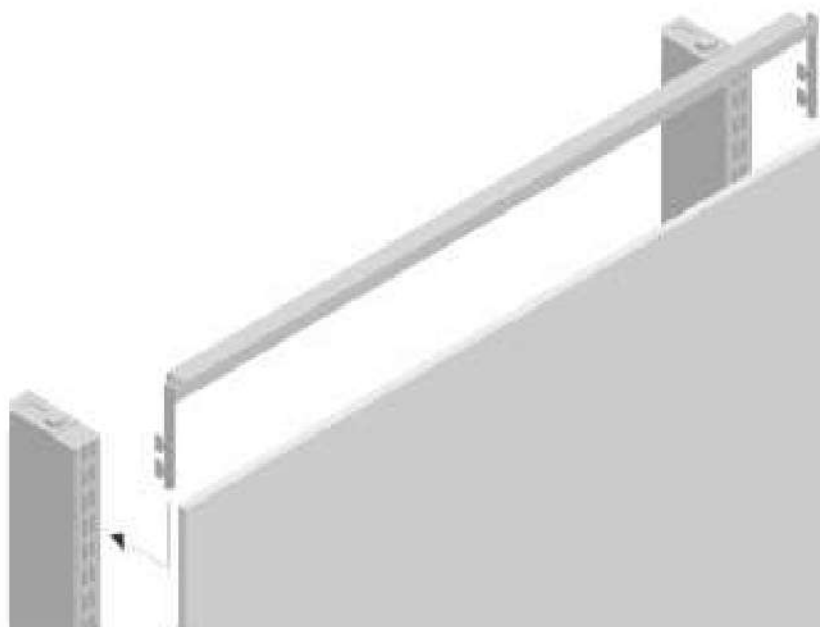

9

#### MONTAGGIO DELLO SCHIENALE LEGNO STRUTTURA CON BASE

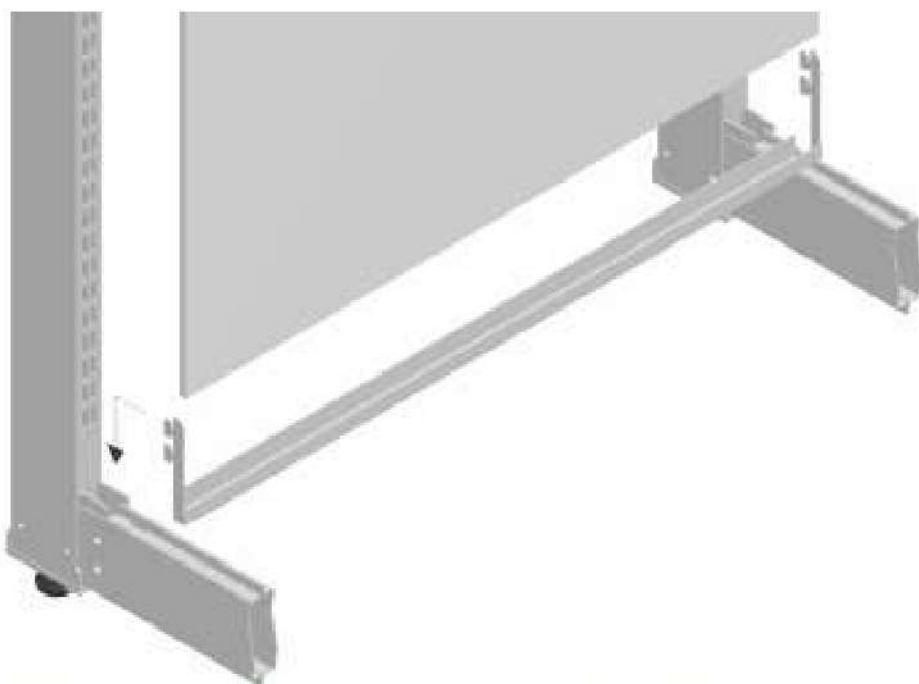

- 1 - Agganciare il reggischienale inferiore alle prime due asole del montante partendo dal basso.
- 2 - Inserire lo schienale nel reggischienale.
- 3 - Inserire il reggischienale nello schienale ed agganciarlo alla terza e quarta asola del montante partendo dall'alto.

## MONTAGGIO DEL PIANO BASE

1 - Fissare le mensole base al piano con Vite T.B.L. M6x10

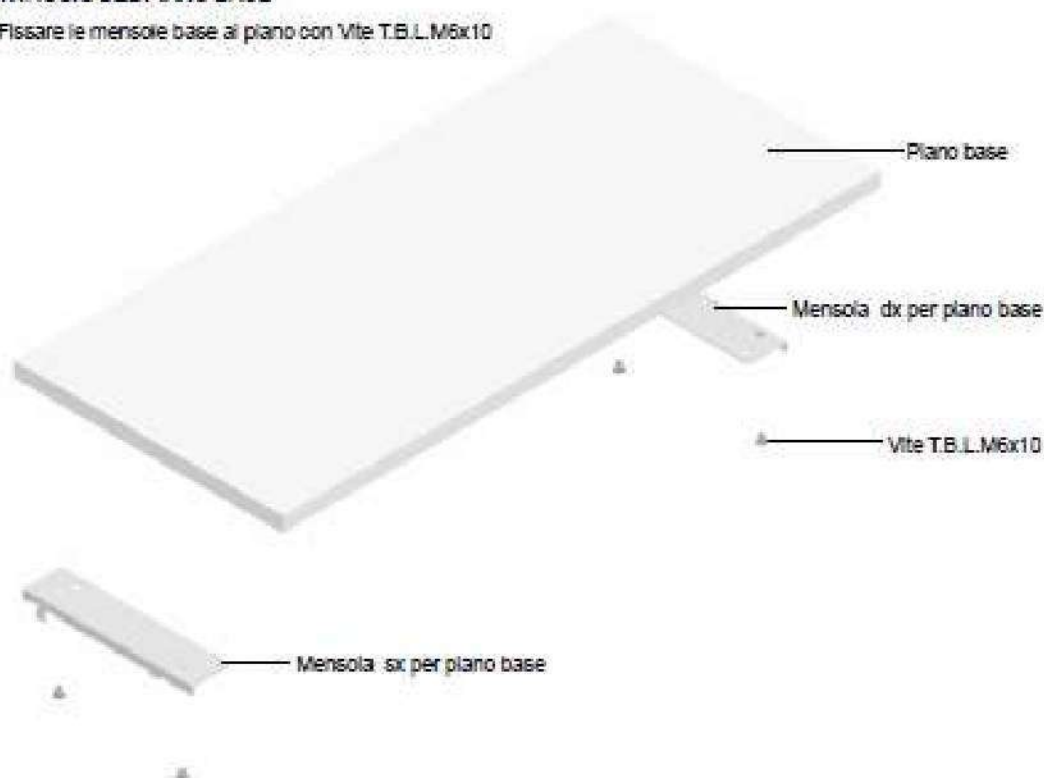

2 - Inserire il gancio delle mensole nelle asole posteriori sopra la base, (lato interno).

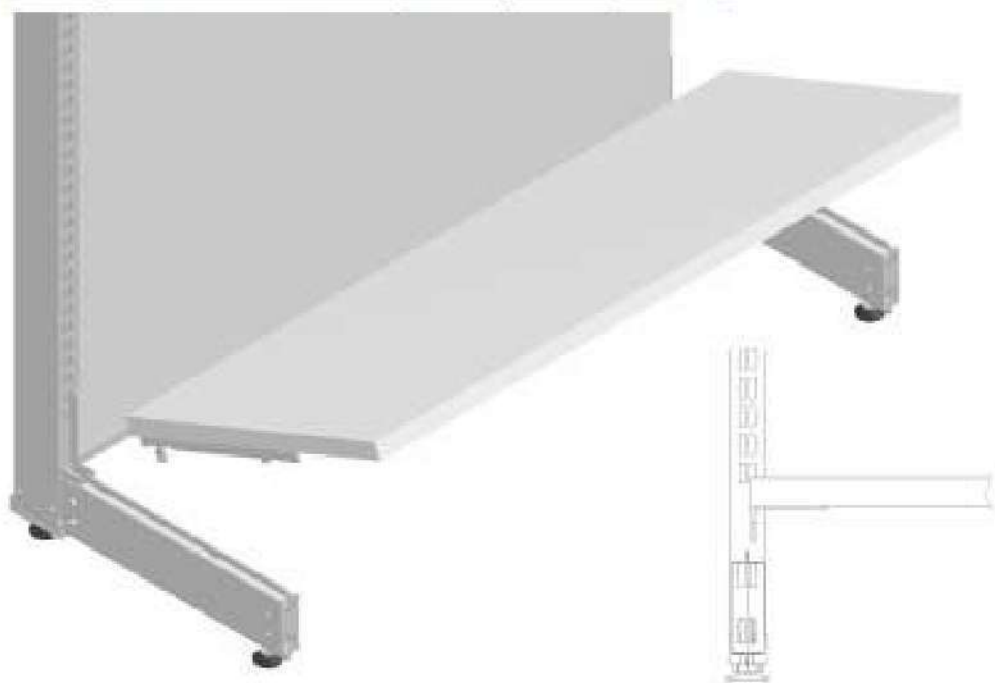



## MONTAGGIO DEL PIANO SOSPESO LEGNO O METALLO

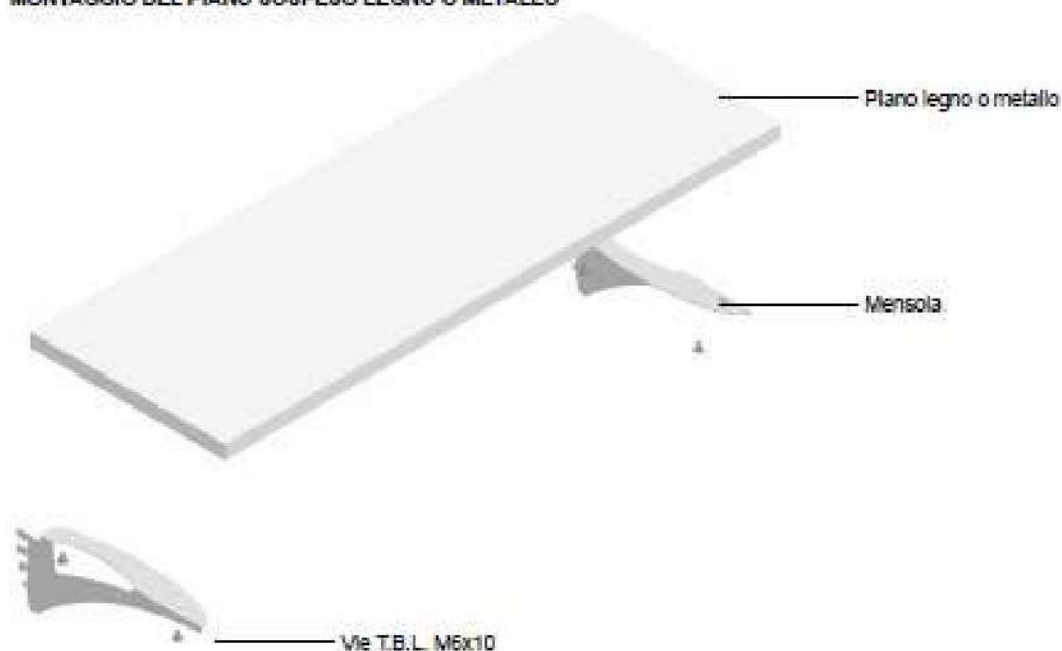

## MONTAGGIO DEL PIANO SOSPESO VETRO

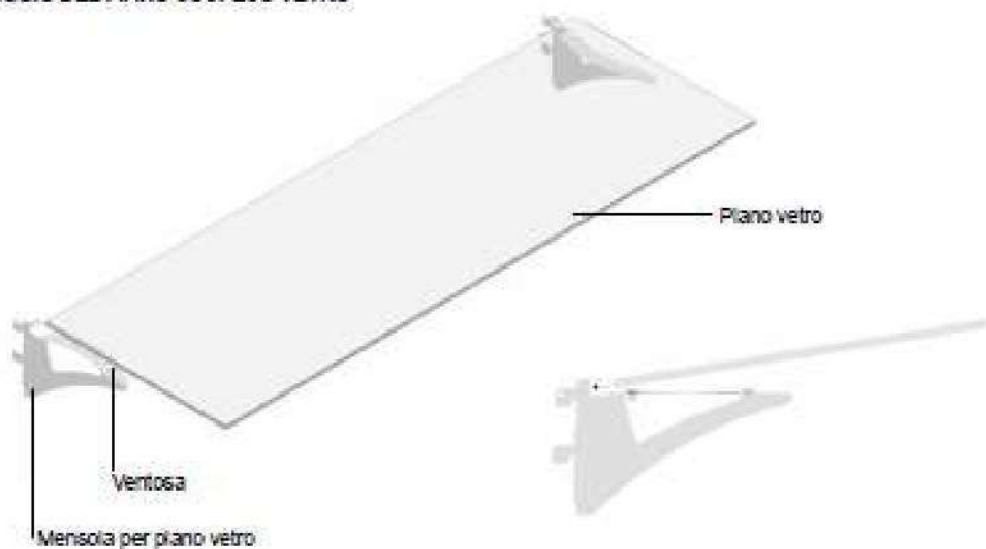

- 1 -Agganciare le mensole al montante all'altezza desiderata e inflare le ventose nei fori sulle mensole.
- 2 -Appoggiare il piano vetro sulle mensole inserendolo sotto l'aletta antiribaltamento.

# CHIUSURE E CORNICI

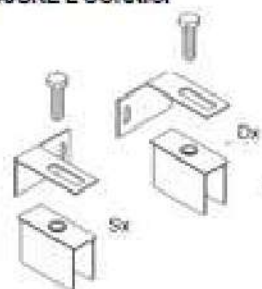
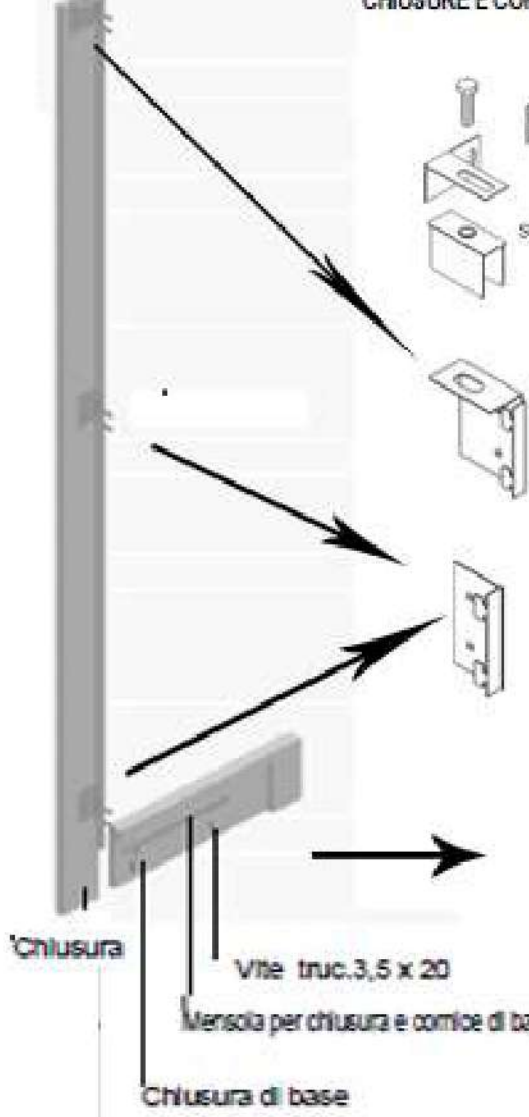

kit montaggio  
inserire nel montante



Plastrino superiore per chiusura



Plastrino per chiusura



Chiusura

Vite truci 3,5 x 20

Mensola per chiusura e cornice di base

Chiusura di base

- 1 - Assemblare i Plastrini alla Chiusura/Cornice con Viti truci 3,5x12.
- 2 - Per l'elemento con base, assemblare la Mensola per chiusura e cornice di base alla Cornice/Chiusura di base.

4 - Per l'elemento con base, agganciare la Chiusura/Comice di base alla base.

N.B. Per la Chiusura di base agganciare il Piastrino per chiusura di base alle asole frontali della base, agganciare la Chiusura di base alla base, fissare il piastrino alla Chiusura di base con Vite truciolare 3,5X12.

